



INDUSTRIES WE CATER TO

- Automotive
- Aerospace
- Medical
- Electronics
- Packaging
- FMCG



SERVICES WE OFFER

- Product Design
- Engineering Design
- Finite Element Analysis
- Injection Molds Design
- Mold Flow Analysis
- Press tool Design
- Jig and Fixture Design
- Special Purpose Machinery
- Legacy CAD Conversion
- Reverse Engineering



Innovate Engineer Experience

Akuva Infotech Pvt. Ltd
www.akuva.com
info@akuva.com

AKUVA INFOTECH PVT. LTD.



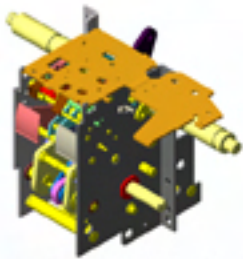

Racking Mechanism

MOLD DESIGN SERVICES

We provide cost effective & quality services for design and development of injection molds, compression molds, blow molds and pressure die casting. Dies for small to medium sized components.

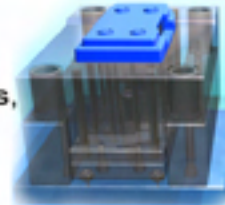

We have auxillary services including mechanical testing, laser scanning, inspection and prototyping and production facilities.



Cover

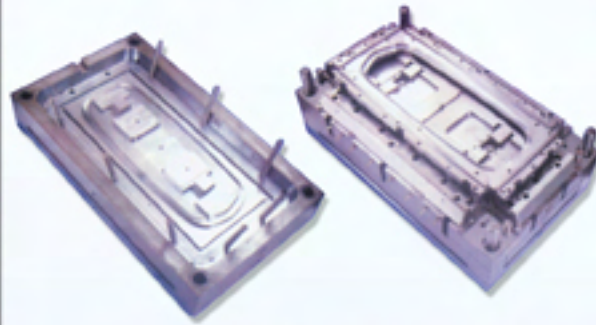

MOLD FLOW ANALYSIS

We cater to many mold manufacturers for their moldability analysis requirements. We can analyse your parts for most parameters including gate locations, fill, cool and warpage. Take advantage of our expertise and quick turnaround times for bringing your products to market faster, better and economically.

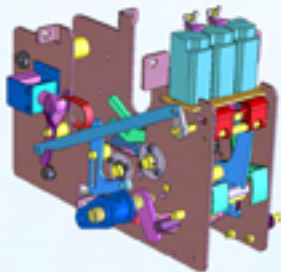

SC Mechanism

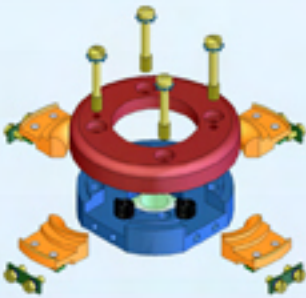
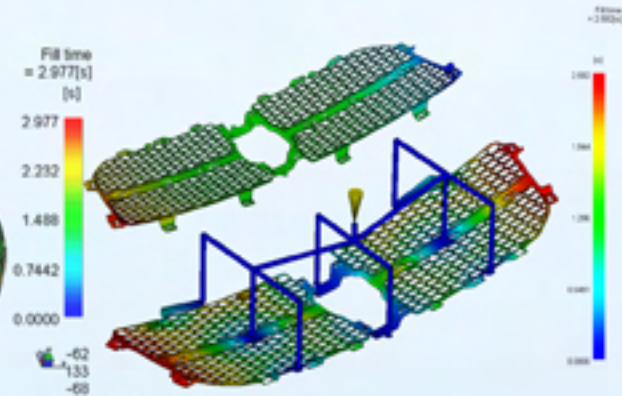
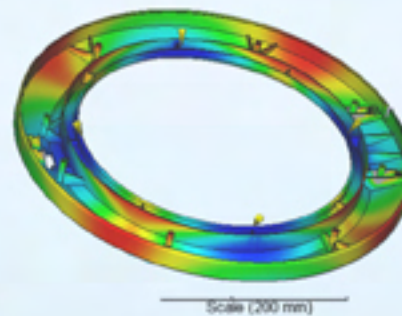

Vacuum Breaker Switch

TOOLS, JIGS & FIXTURES

Our experience in the manufacturing industry has enabled us to provide services which cater to other areas of engineering including press tools, jigs and fixtures and inspection gauges. Whether you are a small, medium or a large scale industry we have a suitable module to fit all your needs.

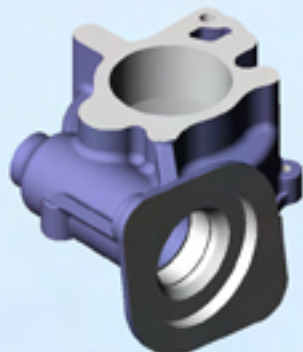

Bearing Support

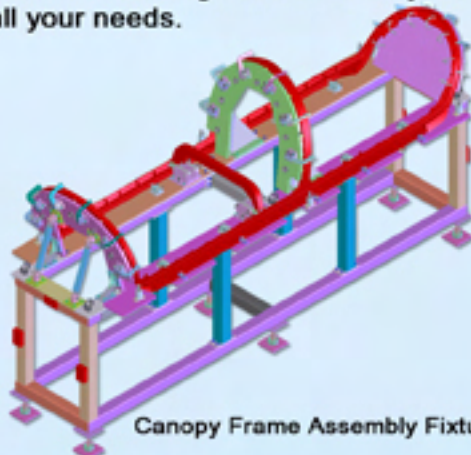

Canopy Frame Assembly Fixture

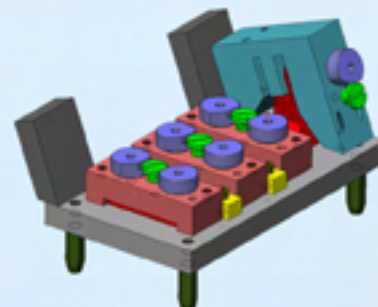

Weld jig and boring fixture



Gate location analysis

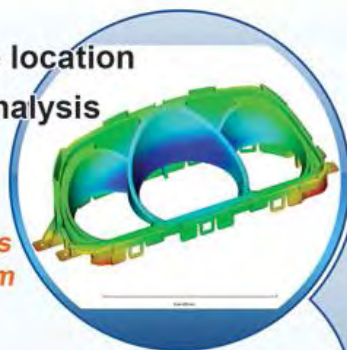

Gate location analysis suggests the optimum position of gate.

Fill & fast fill analysis

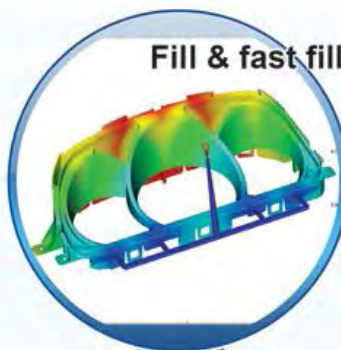

The Fill time result shows the confidence of fill and flow front at regular intervals of time as the cavity fills.

- Delivers optimal results for thick solid geometries.
- Enhanced 3D simulation.
- Improved part meshing, part modeling, and process simulation.
- Updated MPI/3D user interface, solver, modeling and meshing tools, and simulation output.

Warp analysis

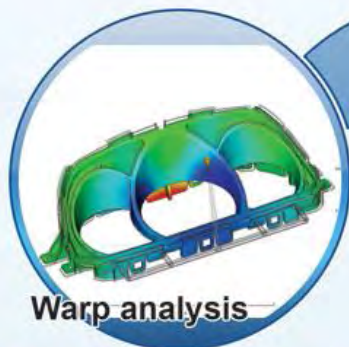

The Deflection/Warp result shows the deflection at each node of the part due to process variables.

Flow analysis

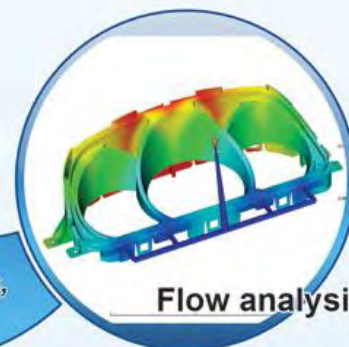

The program simulates flow by calculating a flow front that grows from node to connecting node.

Stress analysis



This result shows stress built up in the component due to process variables.

Cool analysis

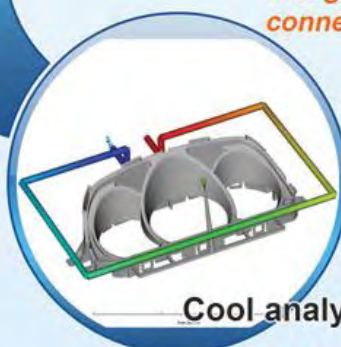

Cool analysis shows whether the cooling circuit is optimum.



Molding Processes Possible

Thermoplastics Injection Molding
Thermoplastics Over-molding
Co-injection Molding

Injection-Compression Molding
Microchip Encapsulation
Multiple - Barrel Reactive Molding





AKUVA INFOTECH PVT. LTD.

INNOVATE ENGINEER EXPERIENCE

RAPIDFORM

3D scan data/STL

Import triangulated 3D scan data or a polygonal mesh model.

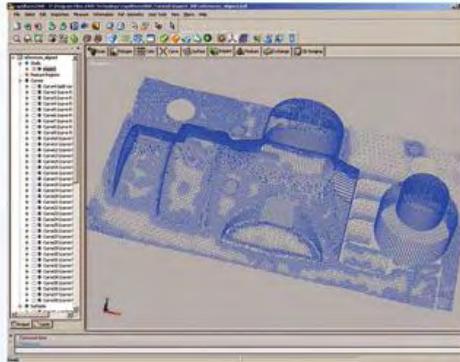

Feature modeling

Design a CAD model by building parameters from the mesh model.

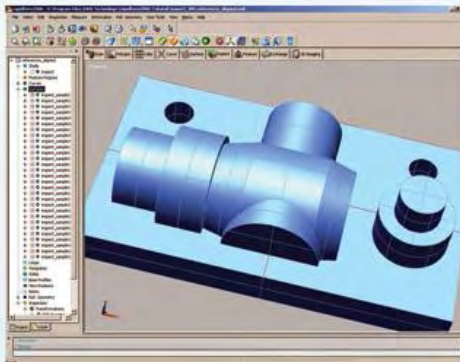

CAD Interoperability

Export parametric solid models created in Rapidform XOR to a variety of CAD applications with full modeling history.

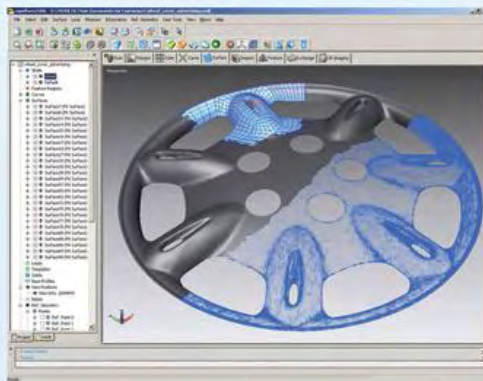

The Titanium's high precision-combined with its light weight construction that provide superb portability-means, that Akuva now has an affordable solution for most of their measurement needs. The Titanium FaroArm enables anyone, anywhere to inspect, reverse engineer or perform CAD-toPart-analysis on parts, fixtures and assemblies with remarkable accuracy.



FARO
The Measure of Success

With a 24/7 customer service and a killer combination of Rapidform and FARO, Akuva team ensures that as a customer you get quality results on time, everytime.

AKUVA INFOTECH PVT. LTD.

No. 61/46, 1st floor, S.N Complex, 3rd main road Hanumanthanagar, Bangalore - 560019
Ph: +9180 - 2667 0416 Telefax: +9180 - 2660 3182 www.akuva.com info@akuva.com



PRODUCT DESIGN

Our strength lies in providing design services from the stage of converting an idea to a concept to the stage of realising the concept to a physical functional prototype and to productionize the same. We work in close harmony with the customer and the manufacturer providing such solutions as industrial design, engineering design and validation, selection of materials, process planning, identification of suitable suppliers and associating with them to bring to the market a successful product. Do get in touch with us now to know how we can add value to your organisation.



Vaccum Cleaner



Syringe Pump

FINITE ELEMENT ANALYSIS

As part of the engineering validation process we provide services for finite element analysis involving structural, thermal, modal, acoustic, fluid analysis. We have expertise in both linear and non-linear static and dynamic analyses.

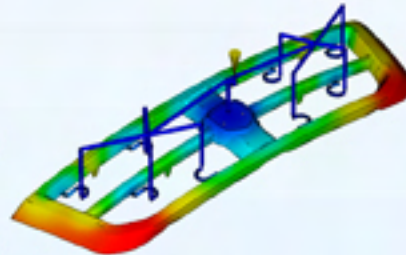
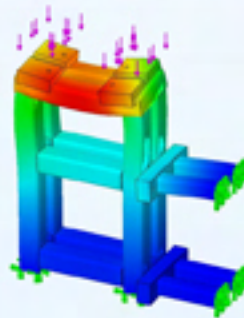
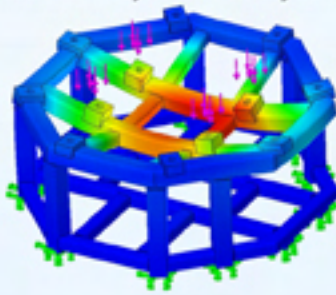

Window Regulator



Eye Wear

SPECIAL PURPOSE MACHINES

An integral part of any industry is the mass production of parts to cater to the evergrowing demand of customers. We take pride in catering to this need by developing innovative and highly productive special purpose machines which can be semi or fully automated as per the clients requirements. Contact us for SPM's for machining, assembly and automated testing and inspection activities.

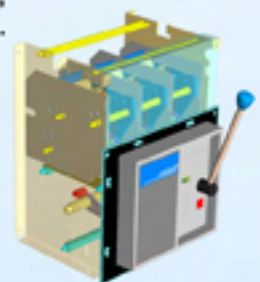
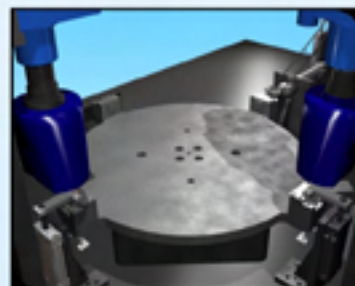
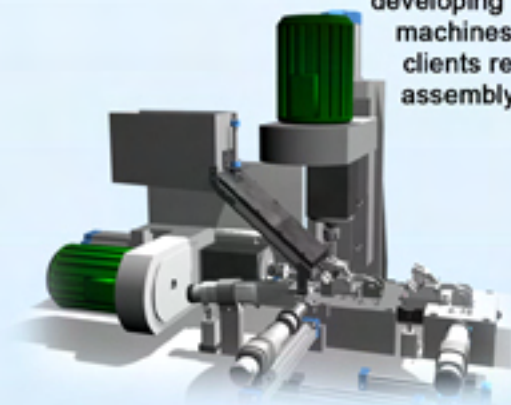

Air Circuit Breaker

LEGACY CAD CONVERSION

Legacy conversion of existing hard copy drawings & translations from one software to another. We have multi language capability for effectively handling Engineering projects from different European countries

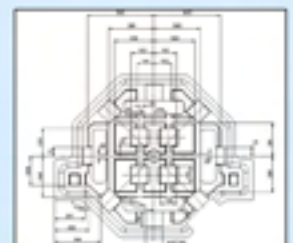
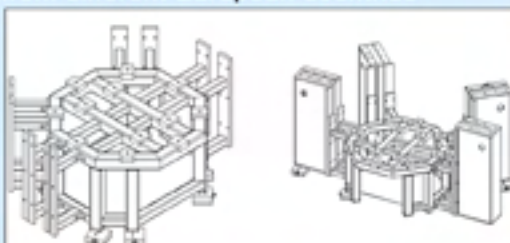

SOFTWARE CAPABILITY

CAD

Pro Engineer
Unigraphics
Catia
Solidworks
Solid Edge
Autodesk Inventor Series
AutoCAD
Key Creator

CAM

Unigraphics
MasterCAM
Pro - Manufacturing

CAE

Ansys
Algor
Hyperworks
Moldflow

RELATED FACILITIES

3D CMM Scanner
Non contact type Laser Scanner
Contact type Faro Arm Laser Scanner
Rapid prototyping and tooling facilities
(FDM, SLA, 3D Printing, Silicon Rubber Molds)
Small to medium size mold manufacturing & proving

Upto 100 tonnes fully automated
molding machines.
3D CNC machining centres.
Conventional tool room.

Akuva Road Map

- Turnover
- Profits
- Order Status
- Resources

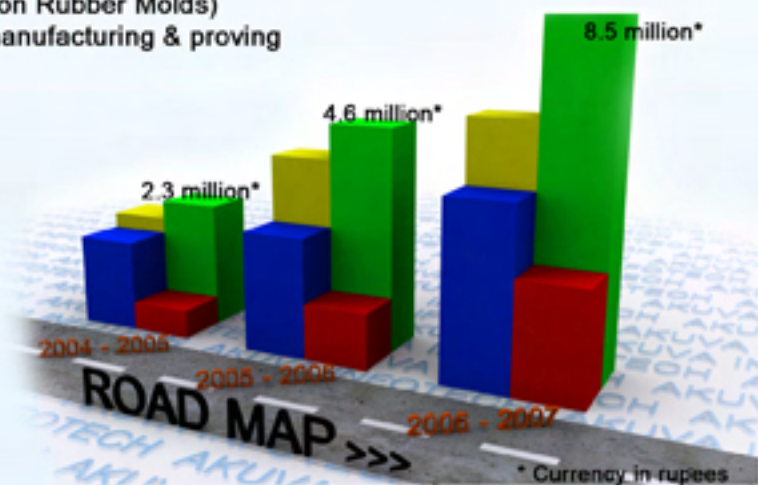

CLIENTELE



AKUVA INFOTECH PVT. LTD.

INNOVATE • ENGINEER • EXPERIENCE

No. 61/46,
1st Floor, S N Complex,
3rd Main Road,
Hanumanthnagar,
Bangalore - 560 019.
Karnataka
India

Ph : +9180 - 2667 0416
Telefax: +9180 - 2660 3182

www.akuva.com
info@akuva.com